

1. Data Sheet¹

Model Number: HCP-722023

2. Dimensions [mm]

▶ Thickness (T)	Max. 7.2(delivery status) Max. 7.8 (after cycling)
▶ Width (W)	Max. 20.5
▶ Length (L)	Max. 23.5(without tabs)
▶ Tab Distance (B)	9.0±2.0
▶ Tab Length (A)	4.0±0.5
▶ Tab Width (C)	2.0±0.2
▶ Top Sealing Width (D)	3.0
▶ Tab Sealant Height (E)	1.5mm for Ref.
▶ Weight Approx. [g]	5.0g

3. Electrical Parameter

▶ Nominal Voltage [V]	3.7 (average)
▶ Typical Capacity [mAh]	275 (0.2C at 20°C)
▶ Min. Capacity [mAh]	265(0.2C at 20°C)
▶ Impedance Initial [mΩ]	<140 @ 1kHz at 4.2V
▶ Max.Continuous Charge Current	120mA (Standard 0.2C)
▶ Max Peak Charge Current	130mA (Standard 0.2C)
▶ Max. Charge Voltage [V]	4.20
▶ Max. Continuous Discharge Current	500 μ A (Standard 0.2C)
▶ Max Peak Discharge Current	400mA,2-3ms (Standard 0.2C)
▶ Discharge Cut off [V]	3.0
▶ Life Expectancy 0.5C / 0.5C	>80% of capacity after 500 cycles @0.2C, 25°C
▶ Operating Temperature [°C]	Charge: 0 to 45 Discharge: -20 to 60
▶ Storage Temperature	6 months at -10 to +35°C

4. Delivery Status

▶ Cell Voltage	3.7V-3.99V
▶ Cell Capacity	50%-75%

5. Date Code Nomenclature

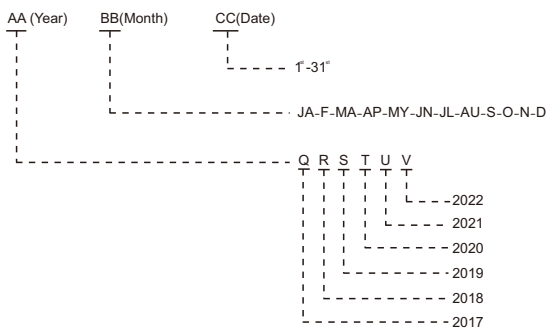

6. Mechanical Drawing (Not in Scale)

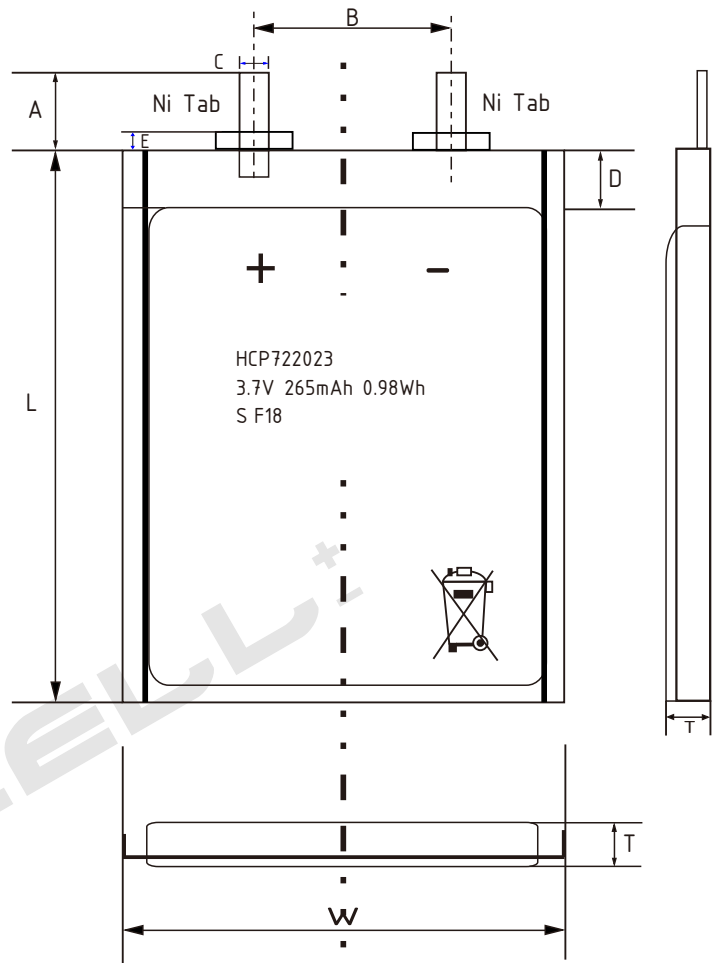

7. Safety Approvals

- ▶ Compliant with RoHS, CE, FCC, UN38.3, REACH,KC,PSE
IEC62133(TUV-CB), UL1642/2054 & GB31241-2014

8. Model Nomenclature

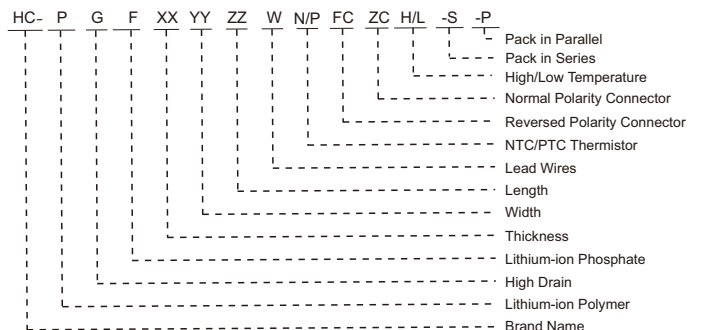

¹ Prior to read Honcell "Handling Precautions and Guidelines for Lithium-ion Polymer Rechargeable Batteries" subject to change without prior notice!

9. Curves

Charge & Discharge (25°C)

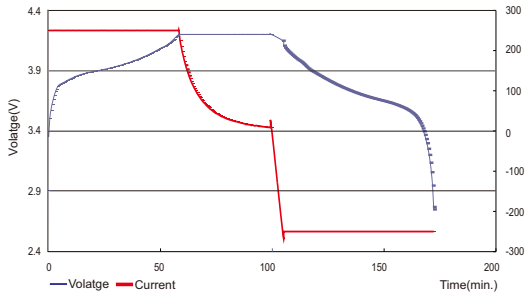

Cycle Life

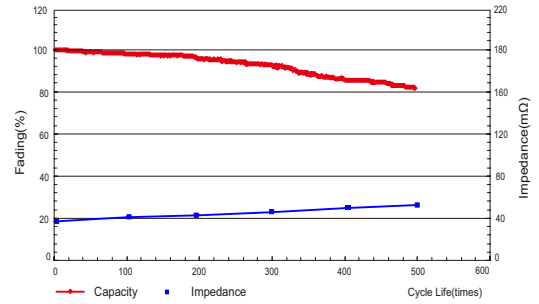

Discharge Characteristics(Temperature)

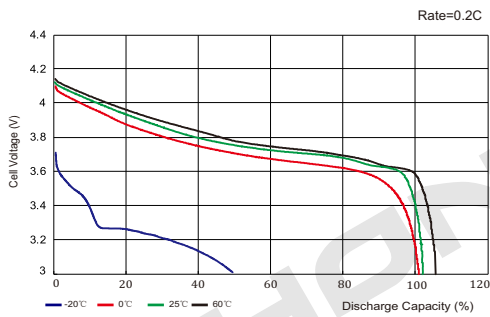

Discharge Characteristics (Rate)

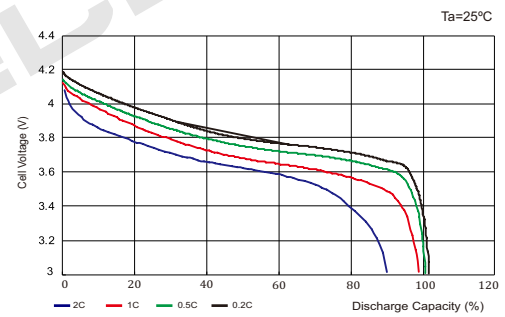

Technical information and contents in this data sheet are for reference purpose only. They do not constitute any warranty or representation and are subject to change without prior notice. For most current information and further details, please contact us.

Shenzhen Honcell Energy Co., Ltd.
612, Bldg. A, Weidonglong Industrial Zone,
Meilong Ave.194#, Longhua New District,
Shenzhen, 518109, China.

[f] +86-755-2100-5221
[f] +86-755-2100-0249

info@honcell.com
www.honcell.com